

技术参数:

- 材料: 压铸铝
- 表面处理: 粉末喷涂
- 颜色: RAL 7037 (灰色)
- 温度范围: -40℃ - +125℃
- 防护等级: IP67 (联锁状态, IEC 60529)
- 出线方向: 顶出线
- 出线孔数: 1
- 螺纹规格: PG21

Technical specification:

- Material: aluminium die-cast
- Surface: powder-coated
- Colour: RAL 7037(grey)
- Temperature range: -40℃ - +125℃
- Degree of protection: IP67
(acc.to IEC 60529 for coupled connector)
- Cable entry: top entry
- No. of cable entries: 1
- Thread size: PG21

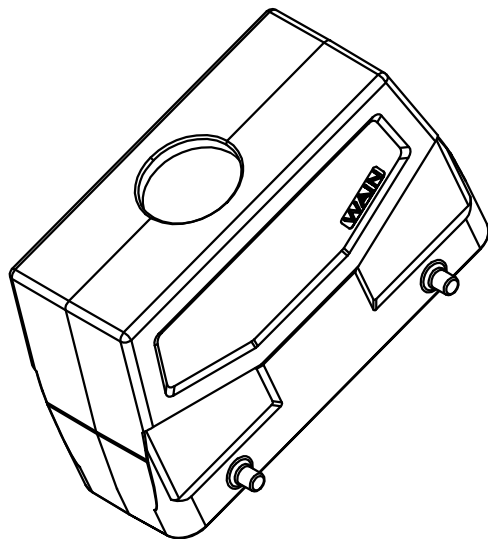

						表面处理 Finish	-			图号 Drawing No.	-
						材料 Material	-			产品代号 Part Code	W24B-TEH-4B-PG21
标记 Mark	处数 Number	变更描述/Description		签名 Signature	日期 Date					产品料号 Part No.	1111244305003
	姓名/Name	日期/Date		姓名/Name	日期/Date	比例 Scale	版本 REV.	重量 Weight	数量 Qty.	产品名称 Part Name	-
绘图 Drawn	SH YE	22.02.2017	标准化 Stand.	-	-	2:3	V1.0	-	-		
审核 Checked	P RAO	22.02.2017									
工艺 Process	-	-	批准 Approved	YY LIN	22.02.2017			All Dimensions in mm Original Size DIN A 4		厦门唯恩电气有限公司 XIAMEN WAIN ELECTRICAL CO.LTD	